



## New Telemecanique LC1-F185 ( LC1F185 ) Contactor Replacement - Data Sheet for US Breaker Brand Contactors with the Trusted UL Certification!

✓ UL Listed: Quality Proven through Global Certifications including Underwriters Laboratory



F185-NC2

### Telemecanique LC1F185 Contactor Replacement Cross Reference

Size Ref	US Breaker- Part #	Telemecanique Cross Reference		Description	Price Each
		Direct	Direct		
F185	F185 P3 V120	LC1F185 - G6	LC1-F185 - G6	3 Pole Contactor 185A (Ith=275A) with 120Vac Coil	\$353.48
F185	F185 P3 V240	LC1F185- U6	LC1-F185 - U6	3 Pole Contactor 185A (Ith=275A) with 240Vac Coil	\$353.48
F185	F185 P3 V480	LC1F185 - T6	LC1-F185 - T6	3 Pole Contactor 185A (Ith=275A) with 480Vac Coil	\$353.48

### Series F NC2 Contactor Technical Data

F NC2 Type		F115	F150	F185	F265
Thermal Current Ith (AC-1) Amps	660V	200	200	275	315
Inductive Current IEC (AC-3) Amps	400V	115	150	185	265
UL Power Rating (Hp)	240V	40	50	60	100
	460V	75	100	100	150
	600V	75	100	100	150
IEC Power Rating (KW AC-3)	230V	33	45	55	80
	400V	55	75	90	132
Operations	Elec.	1,200,000	1,200,000	1,000,000	800,000
	Mech.	10,000,000	10,000,000	6,000,000	6,000,000



### Series F NC2 Contactor Coil Data

2NC Type		F115	F150	F185	F265
Coil Power	Start-up (VA)	660	660	966	840
	Holding (VA)	54	54	66	12
Operation Range of Rated Voltage	Pick-up Voltage	85% - 110%			
	Drop-out Voltage	20% - 75%			

### Series F NC2 Contactor Dimensions

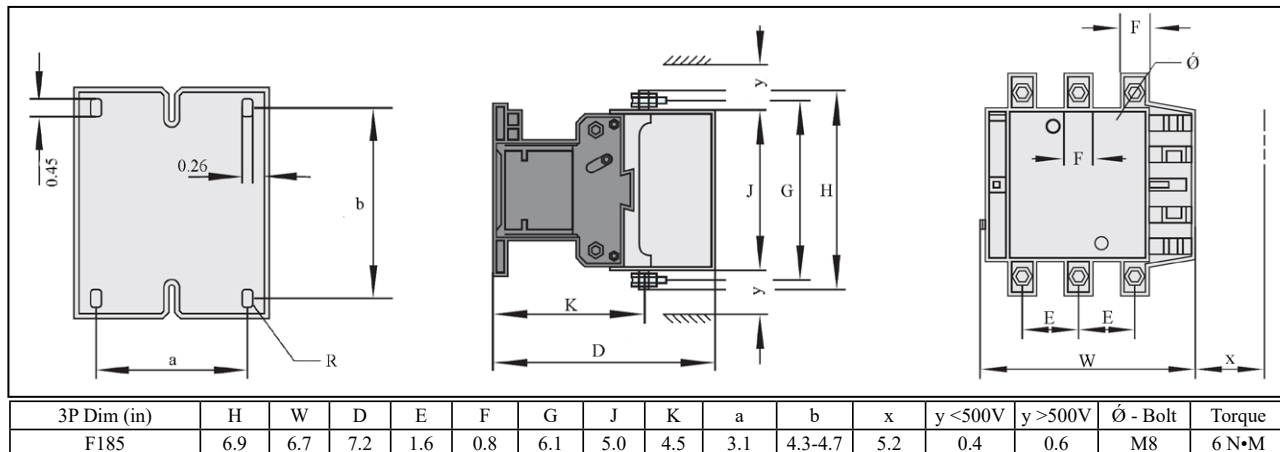

### Auxiliary Contacts

US Breaker- Part #	Telemecanique Cross Ref
NC F4 20	LA1DN 20
NC F4 11	LA1DN 11
NC F4 02	LA1DN 02
NC F4 40	LA1DN 40
NC F4 31	LA1DN 31
NC F4 04	LA1DN 04
NC F4 22	LA1DN 22

### Accessories for F185-NC2 Contactors



NCF411

NCF422

NCF5

### Time Delay Blocks

US Breaker- Part #	Telemecanique Cross Ref
NC F5 T2	LA2DT2
NC F5 D2	LA3DR2

### Mechanical Interlocks

US Breaker- Part #	Telemecanique Cross Ref
NC-MI-185A	-

- Telemecanique part numbers are provided to assist in product selection. Proper engineering evaluation is required for each customer application.
- NC accessories are intended and UL listed for use with their associated NC1D & series F NC2 contactors.